

Nominal Size W x H x D (in)	Actual Size W x H x D (in)	Part Number	Capacity (CFM)	Resistance (in W.G.)	Media Area (sq ft)	Carton Qty	Weight per Carton (lbs)
10 x 10 x 1	9-1/2 x 9-1/2 x 3/4	102-091-020	200	0.27	1.2	12	10
10 x 20 x 1	9-1/2 x 19-1/2 x 3/4	102-499-001	425	0.27	2.4	12	7
12 x 12 x 1	11-1/2 x 11-1/2 x 3/4	102-499-051	300	0.27	1.7	12	10
12 x 18 x 1	11-1/2 x 17-1/2 x 3/4	102-091-001	450	0.27	2.6	12	11
12 x 20 x 1	11-1/2 x 19-1/2 x 3/4	102-091-002	500	0.27	2.9	12	12
12 x 24 x 1	11-3/8 x 23-3/8 x 3/4	102-499-002	600	0.27	3.5	12	9
12 x 25 x 1	11-1/2 x 24-1/2 x 3/4	102-091-003	625	0.27	3.6	12	14
14 x 20 x 1	13-1/2 x 19-1/2 x 3/4	102-499-003	575	0.27	3.4	12	11
14 x 24 x 1	13-1/2 x 23-1/2 x 3/4	102-091-005	700	0.27	4.1	12	15
14 x 25 x 1	13-1/2 x 24-1/2 x 3/4	102-499-004	725	0.27	4.2	12	13
14 x 30 x 1	13-1/2 x 29-1/2 x 3/4	102-091-039	875	0.27	5.0	12	14
15 x 20 x 1	14-1/2 x 19-1/2 x 3/4	102-499-005	625	0.27	3.6	12	11
15 x 25 x 1	14-1/2 x 24-1/2 x 3/4	102-091-006	775	0.27	4.5	12	16
16 x 16 x 1	15-1/2 x 15-1/2 x 3/4	102-091-007	550	0.27	3.1	12	13
16 x 20 x 1	15-1/2 x 19-1/2 x 3/4	102-499-006	675	0.27	3.9	12	11
16 x 24 x 1	15-1/2 x 23-1/2 x 3/4	102-091-008	800	0.27	4.6	12	14
16 x 25 x 1	15-1/2 x 24-1/2 x 3/4	102-499-007	850	0.27	4.8	12	12
16 x 30 x 1	15-1/2 x 29-1/2 x 3/4	102-091-018	1000	0.27	5.7	12	15
18 x 18 x 1	17-1/2 x 17-1/2 x 3/4	102-091-009	675	0.27	3.9	12	14
18 x 20 x 1	17-1/2 x 19-1/2 x 3/4	102-091-015	750	0.27	4.3	12	14
18 x 24 x 1	17-3/8 x 23-3/8 x 3/4	102-091-016	900	0.27	5.2	12	14
18 x 25 x 1	17-1/2 x 24-1/2 x 3/4	102-091-011	950	0.27	5.4	12	14
18 x 30 x 1	17-1/2 x 29-1/2 x 3/4	102-091-044	1125	0.27	6.5	12	15
20 x 20 x 1	19-1/2 x 19-1/2 x 3/4	102-499-008	850	0.27	4.8	12	12
20 x 22 x 1	19-3/4 x 21-1/2 x 3/4	102-091-049	900	0.27	5.3	12	13
20 x 24 x 1	19-3/8 x 23-3/8 x 3/4	102-091-017	1000	0.27	5.8	12	14
20 x 25 x 1	19-1/2 x 24-1/2 x 3/4	102-499-009	1000	0.27	6.0	12	13
20 x 30 x 1	19-1/2 x 29-1/2 x 3/4	102-091-012	1250	0.27	7.2	12	16
24 x 24 x 1	23-3/8 x 23-3/8 x 3/4	102-499-010	1200	0.27	6.9	12	14
24 x 30 x 1	23-1/2 x 29-1/2 x 3/4	102-091-013	1500	0.27	8.7	12	16
25 x 25 x 1	24-1/2 x 24-1/2 x 3/4	102-091-014	1300	0.27	7.5	12	16

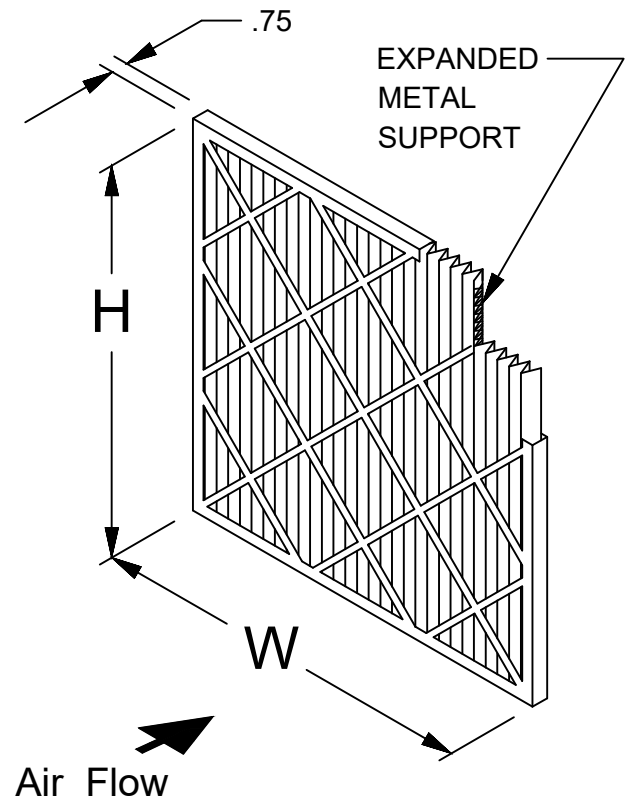

Standard Construction:

1. New White 100% Synthetic Media
2. Rust Resistant Expanded Metal Support on Downstream Side
3. Moisture Resistant Beverage Board Frame (24 point)
4. Double Wall Frame
5. 12 Pleats per Linear Ft.

Notes:

1. All Dimensions are in Inches Unless Otherwise Noted.
2. Drawing Not To Scale

Specifications:

1. Efficiency: MERV 11 (ASHRAE Standard 52.2-2017)
2. Final Resistance: 1.0" W.G.
3. Rated Velocity: 300 FPM
4. Classified per UL Standard 900
5. Max Operating Temp: 200 F (66C)
6. Tolerance: Height & Width - +/- 1/8"
7. Tolerance: Depth - +/- 1/16"

	Multi-Pleat XL11 1" Standard Capacity	REV	REVISION	BY / DATE
		LTR		
8401 Air Commerce Drive - Louisville KY 40219 Phone: (502) 634-4796 FAX: (502) 637-2280	Drawn By: Dave Miller Date: 23 August, 2022	Revision		