

Nominal Size W x H x D (in)	Actual Size W x H x D (in)	Part Number	Capacity (CFM)	Resistance (in W.G.)	Media Area (sq ft)	Carton Qty	Weight per Carton
24 x 24 x 4	23-3/8 x 23-3/8 x 3-3/4	120-614-2424	2000	0.43	68	3	18
25 x 20 x 4	24-3/8 x 19-3/8 x 3-3/4	120-614-2520	1750	0.43	59	3	16
20 x 24 x 4	19-3/8 x 23-3/8 x 3-3/4	120-614-2024	1675	0.43	57	3	15
20 x 20 x 4	19-3/8 x 19-3/8 x 3-3/4	120-614-2020	1400	0.43	48	3	13
18 x 20 x 4	17-3/8 x 19-3/8 x 3-3/4	120-614-1820	1250	0.43	44	3	12
25 x 16 x 4	24-3/8 x 15-3/8 x 3-3/4	120-614-2516	1400	0.43	47	3	13
16 x 24 x 4	15-3/8 x 23-3/8 x 3-3/4	120-614-1624	1350	0.43	46	3	12
16 x 20 x 4	15-3/8 x 19-3/8 x 3-3/4	120-614-1620	1125	0.43	38	3	10
12 x 24 x 4	11-3/8 x 23-3/8 x 3-3/4	120-614-1224	1000	0.43	34	6	10

Standard Construction:

1. Synthetic Media
2. Hotmelt Adhesive Media Separators
3. HIPS Frame

Specifications:

1. Efficiency: Per ASHRAE 52.2-2017 standard
2. Final Resistance: 1.5" W.G.
3. Rated Velocity: 500 FPM
4. Classified per UL Standard 900
5. Maximum Operating Temperature: 150 degrees F (66 C)
6. Tolerance: Height & Width - +/- 1/8"
7. Tolerance: Depth - +/- 1/16"

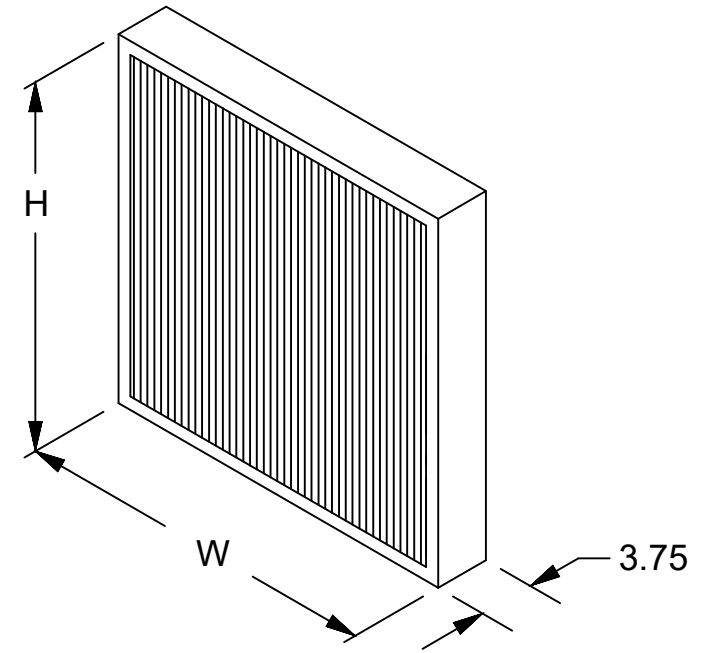

**Micromax PL4S
MERV 15**

REV LTR	REVISION	BY / DATE

8401 Air Commerce Drive - Louisville KY 40219
Phone: (502) 634-4796 FAX: (502) 637-2280

Drawn By: Brent Chamberlain
Date: July 7, 2022

Revision
A