

Nominal Size W x H x D (in)	Actual Size W x H x D (in)	Part Number	Capacity (CFM)	Resistance (in W.G.)	Media Area (sq ft)	Carton Qty	Weight per Carton (lbs)
24 x 24 x 6	23-3/8 x 23-3/8 x 5-7/8	120-46-2424	2000	0.54	125	2	20
25 x 20 x 6	24-3/8 x 19-3/8 x 5-7/8	120-46-2520	1750	0.54	108	2	18
25 x 16 x 6	24-3/8 x 15-3/8 x 5-7/8	120-46-2516	1400	0.54	84	2	14
20 x 24 x 6	19-3/8 x 23-3/8 x 5-7/8	120-46-2024	1675	0.54	103	2	17
20 x 20 x 6	19-3/8 x 19-3/8 x 5-7/8	120-46-2020	1400	0.54	84	2	16
16 x 20 x 6	15-3/8 x 19-3/8 x 5-7/8	120-46-1620	1125	0.54	65	2	12
12 x 24 x 6	11-3/8 x 23-3/8 x 5-7/8	120-46-1224	1000	0.54	57	4	24

Standard Construction:

1. Gradient Density Microfiberglass Media
2. Frame: Plastic Cellsides
3. Media Separators: Hotmelt
4. Sealant: Hotmelt used to seal media pack to cell sides
5. Header Depth: 3/4" Standard
6. Header on Upstream Side of filter

Specifications:

1. MERV 13 (ASHRAE Standard 52.2-2017)
2. Final Resistance: 1.5" W.G.
3. Rated Velocity: 500 FPM
4. Classified per UL Standard 900
5. Maximum Operating Temperature: 175 F (82 C)
6. Tolerance: Height & Width - +0 / -1/8"
7. Tolerance: Depth - +/- 1/16"

Notes:

1. All Dimensions are in Inches Unless Otherwise Noted
2. Drawing Not To Scale

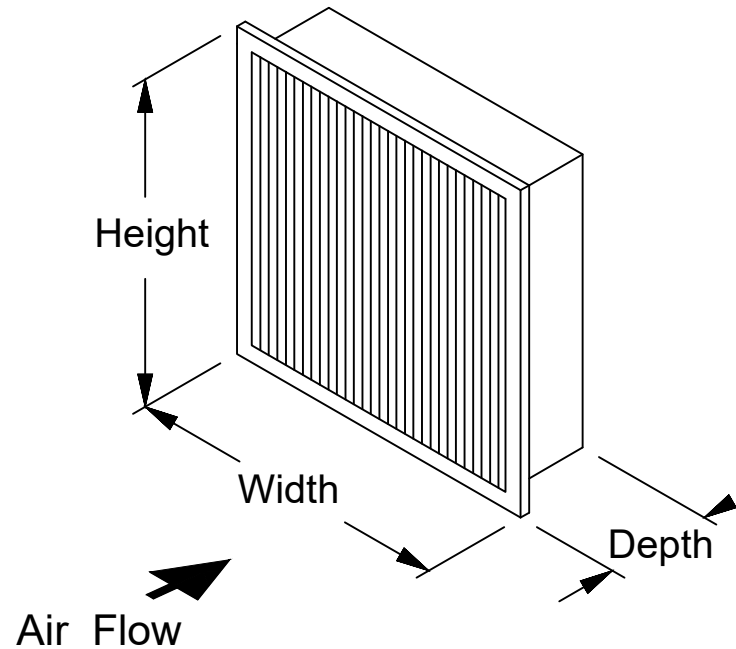

	MicroMAX PL MERV 13 Single Header	REV	REVISION	BY / DATE
		LTR		
8401 Air Commerce Drive - Louisville KY 40219 Phone: (502) 634-4796 FAX: (502) 637-2280	Drawn By: B. Chamberlain Date: May 22, 2023	Revision		